

# EXTRAS b)

rauch ORANGE +

for sliding door wardrobes

Element width 45, 67, 90 cm



Colour	Colour code
Texline Natural-colour linen look	A0066



Texline

These wardrobe widths are comprised of the following units:

	Sliding door wardrobes, 2-door	Options for installing drawer units, Trousers pull-outs, Clothes lifts and pull-out shelves in sliding door wardrobes	Sliding door wardrobes, 2-door	Options for installing drawer units, Trousers pull-outs, Clothes lifts and pull-out shelves in sliding door wardrobes	
↔ 137 cm					
↔ 181 cm					
↔ 226 cm					
↔ 271 cm					
↔ 316 cm					

# EXTRAS b)

rauch ORANGE +

for sliding door wardrobes

Element width **45, 67, 90 cm**





Colour	Colour code
Texline Natural-colour linen look	A0066





ELEMENT WIDTH ▶		45	45	45	45				
						Shelves	hanging rail	pull-out shelf	drawer division
						for unit width 45cm	for unit width 45cm	for unit width 45cm	for pull-out shelf for unit width 45cm
						↔43 cm †2,2 cm ↗50 cm	↔43 cm †3 cm ↗2 cm	↔43 cm †9 cm ↗49 cm	↔31 cm †5 cm ↗44 cm
1 pieces	Price	<b>9644</b>	<b>9715</b>	<b>96R1</b>	<b>96T1</b>				
Set of 2		<b>97F5</b>							
Set of 3		<b>9634</b>							
Set of 4		<b>99J5</b>							



ELEMENT WIDTH ▶		45	45	45			
				<p>* Please note: Please be sure to observe the installation options for sliding door wardrobes.</p>			
						interior drawer	interior drawer
						with 2 drawers for unit width 45cm	with 3 drawers for unit width 45cm
						↔43 cm †45 cm ↗50 cm	↔43 cm †64 cm ↗50 cm
Article	Price	<b>9S81</b>	<b>9S85</b>				

ELEMENT WIDTH ▶		67	67	67				
						Shelves	hanging rail	interior drawer
						for unit width 67cm	for unit width 67cm	with 3 drawers for unit width 67cm
						↔66 cm †2,2 cm ↗50 cm	↔65 cm †3 cm ↗2 cm	↔66 cm †64 cm ↗50 cm
1 pieces	Price	<b>9425</b>	<b>9776</b>	<b>9S89</b>				
Set of 2		<b>97F7</b>						
Set of 3		<b>9426</b>						
Set of 4		<b>99J7</b>						

\* Please note: Please be sure to observe the installation options for sliding door wardrobes.

		Colour	Colour code		
		Texline Natural-colour linen look	A0066		
ELEMENT WIDTH ▶		90	90	90	90
					
		<b>Shelves</b> for unit width 90cm ↔88 cm †2,2 cm ↗50 cm	<b>hanging rail</b> for unit width 90cm ↔87 cm †3 cm ↗2 cm	<b>pull-out shelf</b> for unit width 90cm ↔88 cm †9 cm ↗49 cm	<b>drawer division</b> for pull-out shelf for unit width 90cm ↔76 cm †5 cm ↗44 cm
	1 pieces	Price	<b>9642</b>	<b>9719</b>	<b>98R1</b>
Set of 2		<b>97F8</b>			
Set of 3		<b>9632</b>			
Set of 4		<b>99J8</b>			

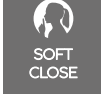
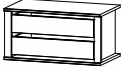
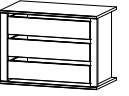
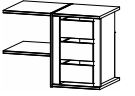
ELEMENT WIDTH ▶		90	90		
					
		<b>1 shelf</b> for unit width 90cm with trouser pull-out ↔88 cm †10 cm ↗51 cm	<b>clothes lift</b> ↔98 cm †84 cm ↗14 cm		
	Article	Price	<b>9Z8C</b>	<b>9314</b>	

ELEMENT WIDTH ▶		90	90	90	90
					
		<b>interior drawer</b> with 2 drawers for unit width 90cm ↔88 cm †45 cm ↗50 cm	<b>interior drawer</b> with 3 drawers for unit width 90cm ↔88 cm †64 cm ↗50 cm	<b>interior drawer</b> with 3 drawers with 2 shelves for unit width 90cm ↔88 cm †64 cm ↗51 cm	<b>interior drawer</b> with 3 drawers with 4 shelves for unit width 90cm ↔88 cm †103 cm ↗51 cm
	Article	Price	<b>9S83</b>	<b>9S87</b>	<b>9SC5</b>

# EXTRAS b)

rauch ORANGE +

for sliding door wardrobes



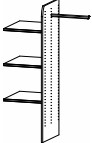
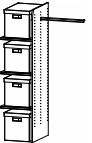
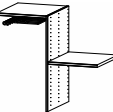
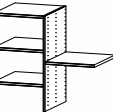

Element width 45, 67, **90** cm



Colour	Colour code
Texline Natural-colour linen look	A0066

ELEMENT WIDTH ▶		90	90	90	90
can be mounted on the left or right					
		wardrobe interior division	wardrobe interior division	wardrobe interior division	wardrobe interior division
		with clothes rail with 3 shelves for unit width 90cm ↔88 cm †148 cm ↗51 cm	incl. 4 fabric boxes with 3 shelves for unit width 90cm ↔88 cm †148 cm ↗51 cm	with trouser holder with 2 shelves for unit width 90cm ↔88 cm †80 cm ↗51 cm	with 4 shelves for unit width 90cm ↔88 cm †80 cm ↗51 cm
Article	Price	<b>9SJ5</b>	<b>9ZS9</b>	<b>9ZH9</b>	<b>9ZK9</b>

		Cupboard extras			
					
		drawer division			
		plexiglass for drawer 80 cm ↔73 cm †9 cm ↗34 cm			
Article	Price	<b>9ZP8</b>			

Colour	Colour code
Texline Natural-colour linen look	A0066

GENERAL					
					
		tie rack swivelling	tie/belt rack	tie/belt rack pull-out	extending rail holder
		↔32 cm ↓27 cm ↗6 cm	↔10 cm ↓13 cm ↗46 cm	↔9 cm ↓6 cm ↗45 cm	↔4 cm ↓6 cm ↗31 cm
Article	Price	<b>9768</b>	<b>990K</b>	<b>9GK1</b>	<b>9760</b>

GENERAL					
					
		hooks	trouser holder	coat hanger rail	
		↔35 cm ↓5 cm ↗5 cm	↔25 cm ↓7 cm ↗46 cm	↔7 cm ↓52 cm ↗28 cm	
Article	Price	<b>9HL1</b>	<b>990H</b>	<b>9767</b>	





# EXTRAS b)

rauch ORANGE +

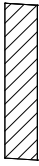
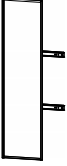



General

Colour	Colour code
Texline Natural-colour linen look	A0066

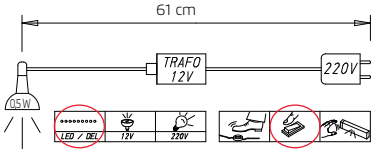
GENERAL					
	interior mirror for hinged doors ↔29 cm †130 cm ↗0 cm		interior mirror, for sliding doors mirror width 31 cm hinged extends from 45 to 73 cm ↔46 cm †115 cm ↗4 cm		
	Article		Price	Article	Price
			<b>98S8</b>		<b>9408</b>

GENERAL		Door dampers rauch EASY SLIDE			
		Installation not possible on wardrobes with front lighting.	Installation not possible on wardrobes with front lighting.	<p><b>NOTE!</b> For fitting the dampers for synchronous sliding-door wardrobes width 316 cm, a room height of wardrobe height + 25 cm is required.</p> <p>Ex: wardrobe height 210 cm + 25 cm = required room height 235 cm</p>	
					
		set of 2 dampers for sliding wardrobes EASY SLIDE of 2-4 door sliding door wardrobes ↔62 cm †2 cm ↗7 cm	damper for middle door EASY SLIDE of 3 door Sliding door wardrobes ↔38 cm †2 cm ↗11 cm		Collision dampers EASY SLIDE of 2 door Sliding door wardrobes
Article	Price	Article	Price	Article	Price
	<b>9DM1</b>	<b>9DM4</b>	<b>9DM6</b>		

BELEUCHTUNG							
	Innenbeleuchtung mit Bewegungsmelder LED-Leuchte ↔23 cm †2 cm ↗11 cm						
	Artikel				Preis	Artikel	Preis
					<b>9T1B</b>		

		Colour	Colour code
		Texline Natural-colour linen look	A0066
BELEUCHTUNG		"LUNA"	"LOFT"
		 	 
		LED-Beleuchtung	LED-Beleuchtung
		Chrom	Alu
		↔21 cm †9 cm ↗33 cm	↔33 cm †5 cm ↗18 cm
2er Set		<b>94L2</b>	<b>9C74</b>
3er Set		<b>94L3</b>	<b>9C76</b>

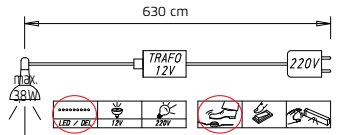
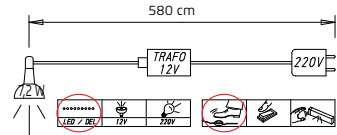
BELEUCHTUNG		"LUNA"	"LOFT"
			
		<p>Dieses Produkt enthält eine Lichtquelle der Energieeffizienzklasse E.</p> <p>EPREL 766798</p>	<p>Dieses Produkt enthält eine Lichtquelle der Energieeffizienzklasse G.</p> <p>EPREL 766530</p>